

Register your product and get support at
www.philips.com/welcome

VOICE TRACER

LFH0652



EN User manual

PHILIPS

Table of contents

1	Welcome	3	6	Playback	11
	Product highlights	3		Playback of a recording or music file	11
				Playback functions	11
				Repeated playback	12
2	Important	4			
	Safety	4			
	Hearing safety	4	7	Delete	14
	Disposal of your old product	4		Deleting files and index marks	14
3	Your Voice Tracer digital recorder	5	8	Customize settings	15
	What's in the box?	5			
	Overview	6			
4	Get started	7	9	Update the firmware	17
	Insert the battery	7			
	Charge the battery	7	10	Frequently asked questions	18
	Power on/off	8			
	Keypad lock (HOLD function)	8			
	Using the Voice Tracer with a computer	8	11	Technical data	19
5	Record	9			
	Record with the built-in microphone	9			
	Record with an external microphone	10			
	Add index marks	10			

1 Welcome

Congratulations on your purchase and welcome to Philips! To fully benefit from the support that Philips offers, visit our Website for support information such as user manuals, software downloads, warranty information and more:

www.philips.com

Product highlights

- ClearVoice – for dynamic enhancement of quiet recording passages giving excellent speech intelligibility
- Instant one-touch recording – from power off to recording with a single key press
- Record in the popular MP3 format
- Speedily transfer recordings and data via high-speed USB 2.0
- Voice-activated recording for hands-free note taking
- USB mass storage ensures maximum compatibility
- Organize recordings quickly and easily with four file folders

2 Important

Safety

- To avoid a short circuit, do not expose the product to rain or water.
- Do not expose the device to excessive heat caused by heating equipment or direct sunlight.
- Protect the cables from being pinched, particularly at plugs.
- Back up your files. Philips is not responsible for any loss of data.

Hearing safety

Observe the following guidelines when using your headphones:

- Listen at reasonable volumes for reasonable periods of time.
- Be careful not to adjust the volume higher as your hearing adapts.
- Do not turn up the volume so high that you can't hear what's around you.
- You should use caution or temporarily discontinue use in potentially hazardous situations.
- Do not use headphones while operating a motorized vehicle, cycling, or skateboarding, etc. It may create a traffic hazard and is illegal in many areas.

Important (for models supplied with headphones):

Philips guarantees compliance with the maximum sound power of its audio players as determined by relevant regulatory bodies, but only with the original model of provided headphones. If these headphones need replacement, we recommend that you contact your retailer to order a Philips model identical to that of the original.

Disposal of your old product

- Your product is designed and manufactured with high quality materials and components that can be recycled and re-used.
- When this crossed-out wheeled bin symbol is attached to a product, it indicates that the product is covered by the European Directive 2002/96/EC.
- Become informed about your local separate collection system for electrical and electronic products.
- Act according to your local rules and do not dispose of old products with normal household waste. The correct disposal of old products will help prevent potential negative consequences for the environment and human health.
- Batteries (including built-in rechargeable batteries) contain substances that may pollute the environment. All batteries should be disposed of at an official collection point.



3 Your Voice Tracer digital recorder

What's in the box?

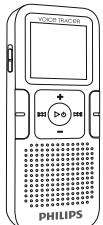

Digital recorder



Quick start guide



1 × AAA battery



USB cable



Clip-on microphone



Stereo headphones

Overview

- ① Record/play indicator
- ② Display
- ③ Hold switch
- ④ Index, Folder, Repeat (**INDEX**/**■**)
- ⑤ Fast rewind, File selection, Set menu option (**⏮**)
- ⑥ Menu (**MENU**)
- ⑦ Power on/off, Play/Pause, Play speed (**▶** **⏸**)
- ⑧ Speaker
- ⑨ Strap hole
- ⑩ Volume up, Menu item selection (**+**)
- ⑪ Record, Pause, Power On (**●** **||**)
- ⑫ Fast forward, File selection, Set menu option (**⏭**)
- ⑬ Stop, Display, Delete (**■**/**DEL**)
- ⑭ Volume down, Menu item selection (**-**)
- ⑮ Microphone jack (**MIC**)
- ⑯ USB socket
- ⑰ Headphones jack (**EAR**)
- ⑱ Integrated microphone

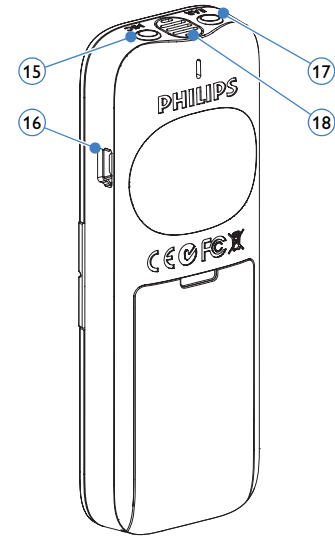
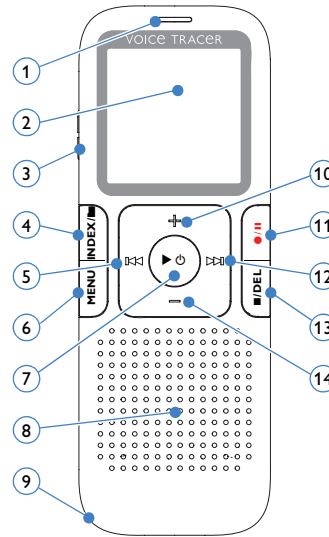

4 Get started

Insert the battery

- 1 Slide open the battery cover.
- 2 Insert the battery as indicated. Make sure the polarity is correct.

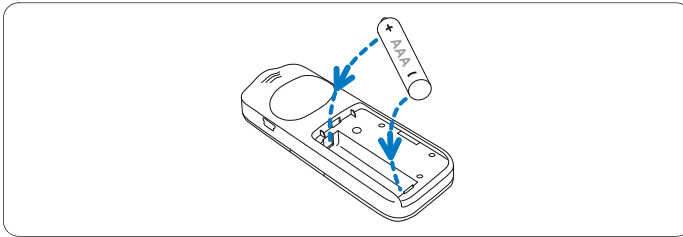

- 3 Close the cover again.

ⓘ Notes

- Remove the battery if you will not be using the Voice Tracer for an extended period. The Voice Tracer could be damaged by a leaking battery.
- If the Voice Tracer does not function properly, remove the battery and re-insert it again.
- Stop the Voice Tracer before replacing the battery. Removing the battery while the recorder is in use may corrupt the file.
- When the battery is nearly empty, the battery indicator blinks.

Charge the battery

The rechargeable battery Philips LFH9154 can be charged in the Voice Tracer. When the Voice Tracer is connected to a computer, the rechargeable battery is automatically charged. A complete recharge cycle takes about 2.5 hours.

ⓘ Notes

- Only the supplied battery Philips LFH9154 can be charged.
- Fully charge the battery before first use.
- The computer must be ON when charging the batteries.
- If the USB port of the computer does not supply enough power capacity, disable the charge function (for details see *chapter 8, Customize settings on page 15*) and use an external battery charger.

Power on/off

- 1 To power on, press the ► ⏻ button until the display shows a short animation [].
- 2 To power off, press the ► ⏻ button while the recorder is stopped until the display shows **BYE**.

Keypad lock (HOLD function)

- 1 Slide the **HOLD** switch up into the Hold position to lock the keypad of the recorder.
 - *The display briefly shows 'On Hold' and turns off.*

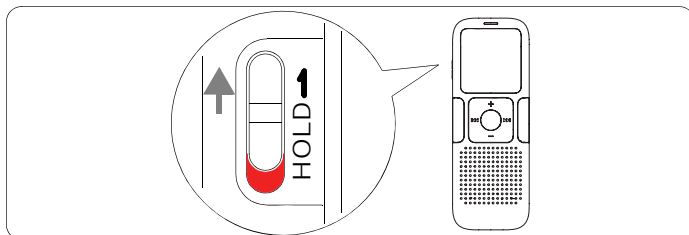

- 2 Slide the **HOLD** switch down to the Off position to disengage the keypad lock.

Using the Voice Tracer with a computer

As a USB mass storage device, the Voice Tracer offers a convenient way to save, back up and move files. The Voice Tracer connects to a computer using a USB connection and does not require special software to be installed. The Voice Tracer is automatically displayed as a removable drive.

⊖ Notes

- Do not disconnect the Voice Tracer from the computer while files are transferred from or to the recorder. The record/play indicator ① flashes orange, when data is being transferred.

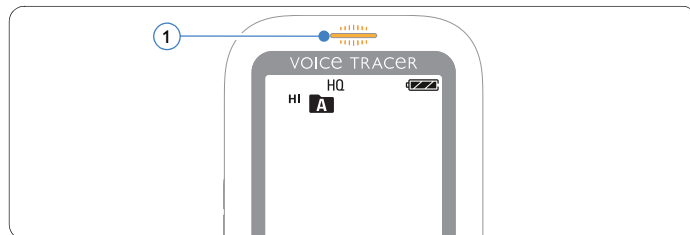

- Do not format the drive of the Voice Tracer on a computer. Formatting on the Voice Tracer uses the correct file system and automatically creates the required folders.

5 Record

Please note the instructions in this section when you make the first recording with your Voice Tracer!

Record with the built-in microphone

- 1 Press the **INDEX/■** button while the recorder is stopped to select the desired folder.
- 2 Press the **●/||** button to start recording.
 - *The record/play indicator lights red.*
 - *Point the built-in microphone toward the sound source.*
- 3 To pause recording, press the **●/||** button.
 - *The record/play indicator will blink, and PAUSE will flash on the display.*
- 4 Press the **●/||** button again to resume recording.
- 5 To stop recording, press the **■/DEL** button.

⊖ Notes

- Set the desired voice activation function and recording mode before starting recording (see *chapter 8, Customize settings on page 15* for more information).
- Make a test recording to make sure that the Voice Tracer settings are correct.
- Press and hold **▶ ⊕** during recording to display the remaining recording time.
- Press **▶▶** during recording to create a new file.
- The maximum number of files in each folder is 99, for a total capacity of 396 files (99 files × 4 folders).
- If the recording time exceeds the available capacity or the number of files reaches 396, recording stops and **FULL** will be displayed. Delete a few recordings or move them to a computer.
- Do not remove the battery when recording is in progress. This can cause the unit to malfunction.
- If you are to start a long recording session, replace the batteries before you begin.

Record with an external microphone

To record with an external microphone, connect the microphone to the microphone jack and follow the same procedure as for the built-in microphone. The built-in microphone is switched off when an external microphone is connected.

Add index marks

Index marks can be used to mark certain points in a recording as points of reference (for example, to mark the start of a new subject of discussion).

- 1 Press the **INDEX**/ button during recording to add an index mark.
 - *The index number is displayed for one second.*

Notes

- The index icon **INDEX** ① indicates that the recording contains index marks.

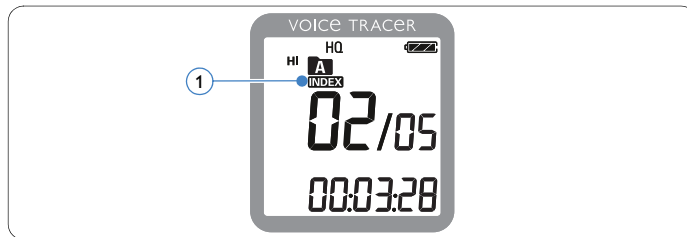

- Up to 32 index marks can be set per file.

6 Playback

Playback of a recording or music file

- 1 Press the **INDEX/■** button while the recorder is stopped to select the desired folder.
- 2 Press the **◀◀** or **▶▶** button to select the file to play back.
- 3 Press the **▶** \odot button.
 - The playback time will be shown on the display, and the record/play indicator will light green.
- 4 Adjust the volume using the **+** and **-** buttons.
- 5 To stop playback, press the **■/DEL** button.
 - The total playback time of the current file will be shown on the display.
- 6 Press the **▶** \odot button again to continue playback from the previous position.

Notes

When headphones are connected to the headphones jack, the recorder speaker will be switched off.

Notes on using the Voice Tracer as a music player

- The recorder supports music files in the formats .wma and .mp3, which can be transferred from the computer to the music folder of the recorder. Files with copy protection (Digital Rights Management, DRM) are not supported.
- The Voice Tracer supports up to two folder levels within the music folder. Each folder can store up to 99 entries (files and folders).

- Press the **▶** \odot button to open a selected folder/file. Press the **INDEX/■** button to return to the folder one level higher.
- Press the **●/||** button during music playback to change the equalizer mode (Off > Pop > Jazz > Classic).

Playback functions

Selecting a file

- 1 While the recorder is stopped, press button **▶▶** briefly to jump to the start of the next file.
- 2 While the recorder is stopped, press button **◀◀** briefly to jump to the start of the previous file.

Slow, fast, normal playback

- 1 Press and hold the ►⏸ button for one second or longer to switch between normal, slow ►► and fast ►►►► playback ①.



Search

- 1 Press and hold the ◀◀ or ▶▶ button during playback to scan backward or forward in the current file at a fast speed.
- 2 Release the button to resume playback at the selected speed.

Rewinding and forwarding / searching for an index mark

- 1 Press the ◀◀ or ▶▶ button during playback to rewind to the beginning of the file being played or forward to the next file. If the file contains index marks, playback starts at the next index mark.

Repeated playback

You can set the Voice Tracer to play files repeatedly or randomly.

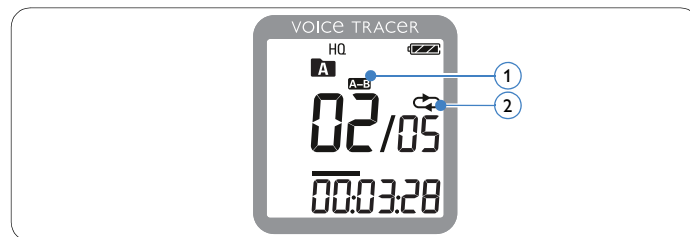

Repeat a sequence

- 1 To repeat or loop a sequence in a file, press the **INDEX/■** button at the chosen start point.
 - The symbol **A-B** ① on the display flashes and the loop symbol ↻ ② appears.
- 2 Press the **INDEX/■** button again at the chosen end point.
 - The repeat sequence begins.
- 3 Press the **■/DEL** button to stop playback or press the **INDEX/■** button to resume normal playback.





Repeat a file or folder

- 1 Press and hold the **INDEX/■** button for one second or longer during playback to switch between play modes (repeat file, repeat folder or playback in random sequence).
- 2 Select the desired playback mode.



Icon	Description
	Repeat a file.
	Repeat all files in a folder.
	Play all music files within folder randomly.

Note



Random playback  is available only in the music folder .

7 Delete

Deleting files and index marks

- 1 Press the **INDEX**/ button while the recorder is stopped to select the desired folder.
- 2 Press and hold the **DEL**/ button for one second or longer.
 - *DELETE* appears on the display.
- 3 Press the **◀◀** or **▶▶** button to select a delete option:

Icon	Description
FILE	Delete a single file.
FOLDER	Delete all files in a folder.
INDEX	Delete all index marks in a file.

- 4 Press the **▶**  button.
- 5 Press the **◀◀** or **▶▶** button to select the file, the folder or the file containing the index marks to be deleted.
- 6 Press button **▶**  again.
 - *NO* appears.
- 7 Push button **◀◀** or **▶▶** to select **YES**.
- 8 Press the **▶**  button to confirm.

Note





The files will be automatically renumbered.





8 Customize settings



You can customize the settings of your Voice Tracer to suit the recording conditions and your personal preferences.

- 1 Press the **MENU** button while the recorder is stopped.
 - The display shows *MODE* and the current setting for recording mode is flashing.
- 2 Press the **+** or **-** button to navigate the setting icons bar up or down.
- 3 Press the **◀◀** or **▶▶** button to change the displayed setting. The new setting is automatically accepted (exceptions: the **FORMAT** and **SPLIT** functions must be confirmed by pressing the **▶** **⏻** button).
- 4 Customize settings as required or exit the menu by pressing the **MENU** button.

Icon/Display	Option	Description
SLP		Choose among several recording modes including uncompressed PCM format, SHQ, HQ, SP, LP or SLP for a longer recording time. Refer to <i>chapter 11, Technical data on page 19</i> for details.
LP		
SP		
HQ		
SHQ		
PCM		

Icon/Display	Option	Description
 MIC	HI LO	Adjust the recording sensitivity to avoid recording background noises and to adjust to the recording environment.
 VA	On Off	Voice-activated recording is a convenience feature for hands-free recording. When voice-activated recording is enabled, recording will start when you begin speaking. When you stop speaking, the recorder will automatically pause recording after three seconds of silence, and resume only when you begin speaking again.
 CLVOICE	On Off	Dynamic emphasis on quiet passages to improve the intelligibility of quiet voices.
 BEEP	Yes No	The recorder gives sound feedback about button operations or errors.

Icon/ Display	Option	Description
 AUTOOFF	5 15	The Voice Tracer automatically turns off after 5 or 15 minutes of inactivity
 FORMAT	No Yes	Delete all files on the recorder. Transfer important files to a PC before formatting the memory. Press ► ⏻ to confirm the selection.
 INFO		Display the firmware version and the release date. Example: 100 06/01/2010
 LIGHT	On Off	The display remains illuminated for a few seconds when a button is pressed.
 SPLIT	No Yes	Split a large file into two separate files so that it can be more easily archived or transferred via e-mail, or to delete a section of the file. To split a file, play and stop at the position where the split should be made, then open the SPLIT menu. Press the ► ⏻ button to confirm your selection.

Icon/ Display	Option	Description
 DIVIDE	30 60 Off	The auto divide feature automatically records into a new file every 30 or 60 minutes. This makes it much easier to find, edit and archive long recordings such as meetings or lectures.
 CHARGE	On Off	When charging is enabled, the rechargeable battery is automatically charged when the Voice Tracer is connected to a computer.
 EQUALI	Pop Jazz Clas Off	This setting improves the listening experience when playing back music by custom frequency settings. Select the appropriate setting for your music.

9 Update the firmware

Your Voice Tracer is controlled by an internal program called firmware. As a part of ongoing product maintenance, the firmware is revised and errors are corrected.

It is possible that a newer version (an "update") of the firmware has been issued since you purchased the Voice Tracer. In this case you can easily update your recorder to the latest version.

- 1 Connect the Voice Tracer to your computer using the supplied USB cable.
- 2 Download the firmware update for your Voice Tracer from www.philips.com onto your computer.
- 3 Copy the new firmware file to the root directory of the Voice Tracer.
- 4 Disconnecting the Voice Tracer from the computer automatically updates the firmware.

Notes

- Please note that the firmware file must be located in the root directory to allow automatic updating.
- The firmware file will be deleted automatically after the update has been carried out. The Voice Tracer will then switch off.

10 Frequently asked questions

The answers to frequently asked questions listed here are intended to solve simple problems with the Voice Tracer. If you have no success please contact your dealer or visit our website:

www.philips.com/support

My Voice Tracer cannot power on.

- The battery is flat or has been inserted incorrectly. Replace the battery with a new one and make sure that it is inserted correctly.
-

My Voice Tracer does not record anything.

- The Voice Tracer is in HOLD mode. Slide the HOLD switch to the "Off" position.
 - The maximum number of recordings may be reached or the recording capacity is full. Delete some recordings or move recordings to an external device.
-

I cannot hear anything from the speaker.

- The headphones may be plugged in. Remove the headphones.
 - The volume is at the lowest setting. Adjust the volume.
-

My Voice Tracer cannot play recordings.

- The Voice Tracer is in HOLD mode. Slide the HOLD switch to the "Off" position.
 - The battery is flat or has been inserted incorrectly. Replace the battery with a new one and make sure that it is inserted correctly.
 - Nothing has been recorded yet. Check the number of recordings.
-

My Voice Tracer cannot stop, pause, play or record.

- The Voice Tracer is in HOLD mode. Slide the HOLD switch to the "Off" position.
-

I cannot hear anything through the headphones.

- The headphones may not be plugged in properly. Plug in the headphones properly.
 - The volume is at the lowest setting. Adjust the volume.
-

11 Technical data

Connectivity

Headphones jack	3.5 mm Impedance: 16 Ω or above
Microphone jack	3.5 mm Impedance: 2.2 k Ω
USB	High-speed USB 2.0, mini USB port

Display

Type	LCD / segment
Screen size	34.5 mm / 1.4 "
Backlight	white

Memory

Built-in memory capacity	2 GB
Built-in memory type	NAND Flash
Mass storage class compliant	yes

Recording

Format	MPEG1 Layer 3 (MP3) PCM (WAV)
Microphone	built-in high-sensitivity, low-noise microphone, mono
Recording modes	PCM (WAV/mono) SHQ, HQ, SP, LP, SLP (MP3/mono)
Bit rate	PCM: 705 kbit/s SHQ: 192 kbit/s HQ: 64 kbit/s SP: 48 kbit/s LP: 32 kbit/s SLP: 8 kbit/s
Recording time (approx.)	SLP: 566 hours LP: 142 hours SP: 95 hours HQ: 70 hours SHQ: 24 hours PCM: 6.4 hours
Sample rate	PCM/SHQ: 44.1 kHz HQ: 22 kHz SP/LP/SLP: 16 kHz

Speaker

Type	built-in dynamic speaker
Diameter	23 mm / 0.9 "
Output power	110 mW
Sound enhancement	ClearVoice

Music playback

Compression format	MP3, WMA
MP3 bit rate	8–320 kbit/s
WMA bit rate	48–320 kbit/s (44 kHz), stereo 64–192 kbit/s (48 kHz), stereo
Digital rights management (DRM)	not supported
Equalizer settings	Pop, Jazz, Classic

Battery

Type	AAA/LR03 Alkaline or Philips AAA NiMH rechargeable bat- tery LFH9154
Number of batteries	1
Rechargeable	yes, via USB with Philips NiMH rechargeable battery LFH9154
Lifetime	up to 22 hours (in SLP recording mode)

System requirements

Operating system	Windows 7/Vista/XP/2000, Mac OS X, Linux
Interface	available USB port

Operating conditions

Temperature	5° – 45°C / 41° – 113°F
Humidity	10% – 90%, non-condensing

Dimensions and weight

Width × height × depth	38 × 105 × 16.4 mm / 1.5 × 4.1 × 0.6 "
Weight incl. battery	55 g / 0.12 lb



Specifications subject to change without notice.

Trade marks are the property of Royal Philips Electronics or their respective owners.

© 2010 Royal Philips Electronics. All rights reserved.

Document version 2.0, 08/08/2010.